

# CATALOG

---

## 2023.3



LA  MARE

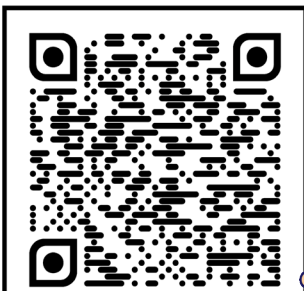

DOWNLOAD CATALOG



**TABLE OF CONTENTS:**

<b>1. LIGHTING</b>	<b>4</b>	<b>21. SWITCHES, SOCKETS, SOLAR SYSTEM</b>	<b>29</b>
1.1 INTERIOR LIGHTING	4	22. HEATING AND BOILER	30
1.2 OUTDOOR LIGHTING	4	22.1 HEATING FURNACE	30
1.3 OUTDOOR LIGHTING ON TERRACES	5	22.2 BOILERS	31
<b>2. INSIDE DOOR</b>	<b>5</b>	23. DECORATIVE RADIATOR	32
<b>3. DULUX PAINT</b>	<b>6</b>	24. BATHROOM LADDER HEATER	33
<b>4. EXTERNAL CLADDING</b>	<b>7</b>	25. GAS BOX AND GAS SWITCH	33
4.2 VINYLIT FACADE	7	ADDITIONAL EQUIPMENTS	35
4.1 VOX	7	26. FLOATING PACKAGE	36
<b>5. FLOOR</b>	<b>8</b>	26.1 NAVIGATION LIGHT AND ROPES	36
5.1 KRONOSPAN ROCKO	8	26.2 SONARS	36
5.2 IVC LAYRED 55	8	26.3 ENGINES	37
<b>6. SKIRTING BOARD</b>	<b>9</b>	26.4 STEERING CONSOLE AND WHEEL	38
<b>7. CEILING</b>	<b>9</b>	26.5 ANCHOR, BEAMS AND FLOATS	39
<b>8. BATHROOM WALL COVERING</b>	<b>10</b>	27. MODIFIED WINDOWS AND DOORS	40
<b>9. BATHROOM CABINET AND SINK</b>	<b>12</b>	28.1 SPIRAL	41
<b>10. SHOWER ENCLOSURE</b>	<b>13</b>	28. STAIRCASE	41
<b>11. TOILET</b>	<b>13</b>	28.3 LADDER	41
<b>12. IKEA KITCHEN</b>	<b>14</b>	28.4 FRONT STRAIGHT	41
12.1 KITCHEN FRONTS	14	28.2 STRAIGHT	41
12.2 WORKTOP	16	29. SIDE RAILINGS AND FLEXI TEAK	42
12.2.1 KITCHEN WALL	17	30. WATER-WASTE SYSTEMS	43
12.3 SINK	18	31. BEDROOM	44
12.4 KITCHEN TAPS	20	31.1 WARDROBE AND BED	44
12.5 HANDLES	22	32. TV, RADIO AND SOCKET	45
<b>13. KITCHEN STOVE AND FRIDGE</b>	<b>24</b>	33. SAUNA AND GRADUATION TOWER	46
<b>14. MICROWAVE AND DISHWASHER</b>	<b>25</b>	34. CURTAINS	46
<b>15. OVEN</b>	<b>25</b>	35. BLINDS	47
<b>16. BAR</b>	<b>26</b>	36.1 EXTERNAL COLORS	48
16.1 BAR TABLE	26	36. MODERN	48
16.2 BAR LAMP	26	36.2 KITCHEN, BATHROOM TAPS	49
<b>17. OUTSIDE WINDOWS AND DOORS</b>	<b>27</b>	AND SHOWERS	49
<b>18. RAILINGS</b>	<b>28</b>	36.3 BATHROOM CABINETS	50
MADE OF STAINLESS STEEL	28	36.4 FABRIC WALLS	50
<b>19. TERRACE BOARD AND CLEAT</b>	<b>28</b>	36.5 KITCHEN LAYOUT	51
<b>20. WATER POMPS</b>	<b>29</b>	37. LAYOUTS	52

LAMARE OPTION CHOICES



# 1. LIGHTING

## 1.1 INTERIOR LIGHTING



LED STRIPS

## 1.2 OUTDOOR LIGHTING



LED STRIPS

## 1.3 OUTDOOR LIGHTING ON TERRACES



LED SPOTLIGHTS

# 2. INSIDE DOOR



VECTOR Premium  
MODEL E



VECTOR Premium  
MODEL E with porthole

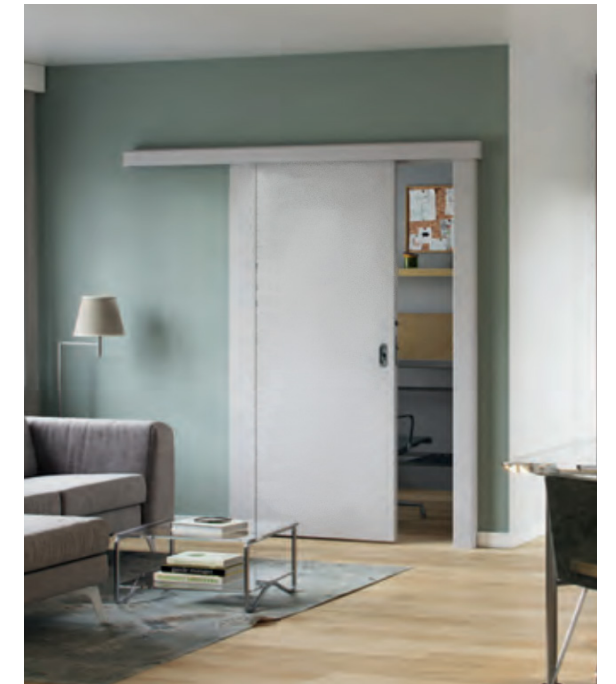

Sliding Door vector  
Options



Magix inox

We know that for every human being is the most important house, and each house begins with a door. They open and close intimate world in which we want to feel happy and safe.

Our passion is to create such a door that will be open with the desire and joy, to overstep the threshold in the most important place for you in the world - your home.



### 3. DULUX PAINT



SCANDINAVIAN GREY

You can choose any colour from the Dulux pallet

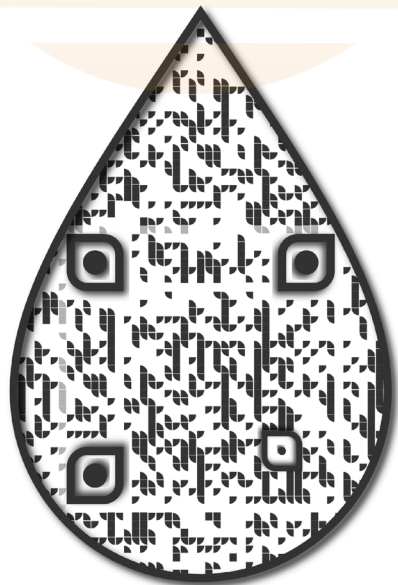

The Dulux Visualizer App

An overview of paints that will help you deliver the perfect results for any project

### 4. EXTERNAL CLADDING

#### 4.1 VOX



Modern Wood, White



Modern Wood, Claystone

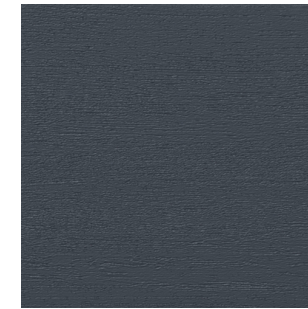

Modern Wood, Anthracite



Modern Wood, Ivory



Modern Wood, Pearl Grey

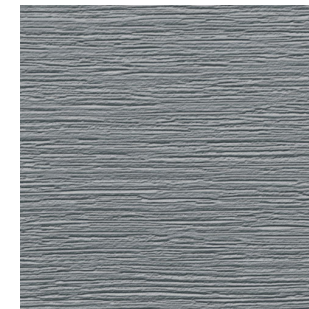

Modern Wood, Quartz Grey



Concrete Oak only FS-304



Malt Oak only FS-304

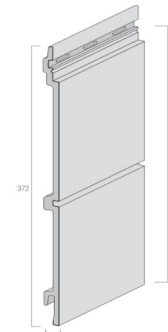

Double board FS-302

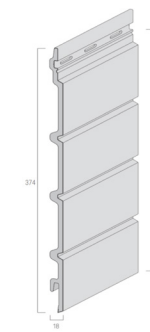

Fourfold board FS-304

VOX  
Cladding  
board types

#### 4.2 VINYLIT FACADE

#### OPTIONS



Sheffield Concrete Oak with Shadow

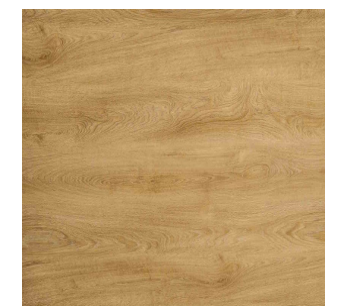

Turner Malt Oak with Shadow



# 5. FLOOR

## 5.1 KRONOSPAN ROCKO



R070 INCANDO



R076 BOURBON CASK



R077 BARISTA



R090 CASTLEBRIDGE



R081 CRESCENDO



R082 HUMIDOR



The KRONOSPAN brand focuses its attention on the person, its needs and values, which is why we create our products and services, utilizing the knowledge from various humanistic disciplines. Thanks to the cooperation with psychologists, sociologists or anthropologists, we are able to design solutions, which support our customers in developing interiors, which provide freedom and enable fulfilling life passions.

## 5.2 IVC LAYRED 55



COUNTRY OAK 54945



COUNTRY OAK 24277



COUNTRY OAK 24842



LAUREL OAK 51992

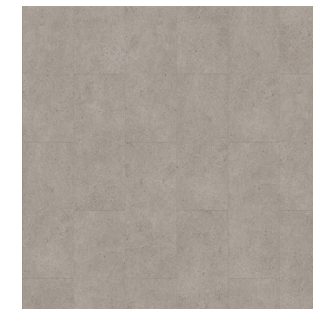

VENETIAN STONE 46949

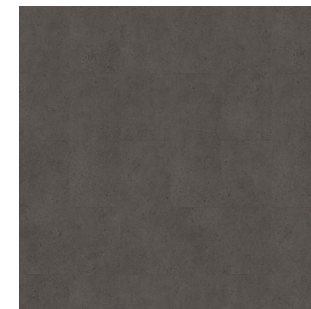

VENETIAN STONE 46981



LayRed is the engineered vinyl floor collection from Moduleo: a rigid flooring solution with a strong core, yet with a soft feel and silent acoustics. A premium quality floor with integrated underlay – the signature red back of Moduleo LayRed – engineered to stand its ground in any room and designed to be beautiful everywhere.

## 6. SKIRTING BOARD



GRAY



BROWN

## 7. CEILING

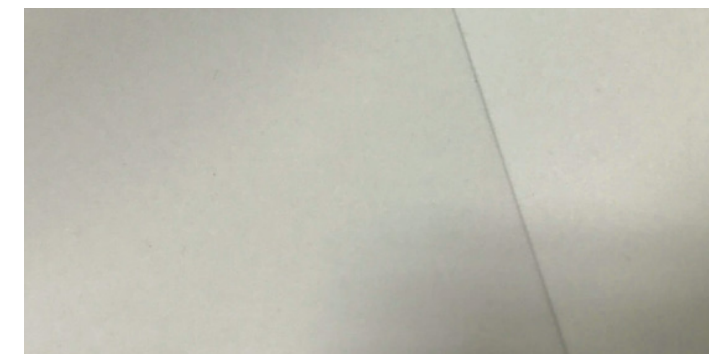

MATT



# 8. BATHROOM WALL COVERING

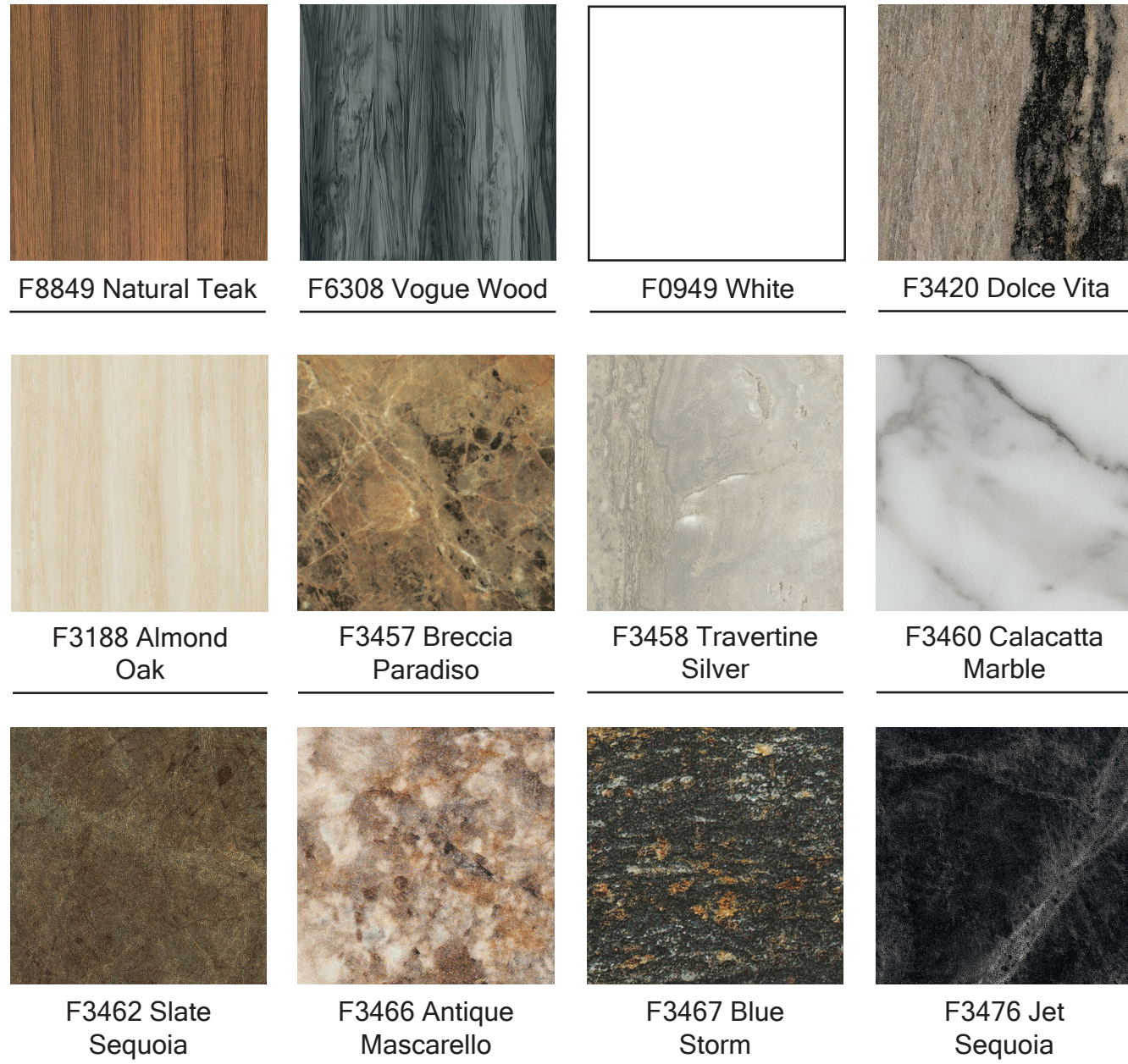

PREMIUM GLOSS FINISH by FORMICA GROUP

AR+ is a High Gloss HPL with a superior scuff and mar resistance and therefore usable on vertical and horizontal surfaces. Formica's own laboratory tests show remarkable results. It has also been tested externally by LGA Institute with official certification of AR+ superior performance. Steel wool? Yes, one has to push really hard to get even the smallest scuff on AR+. It is also available in other designs and trendy colours.

AR+ not only performs better in scuff and mar resistance than any gloss HPL product in the market, but it also keeps the gloss level after heavy use. AR+ is a durable high gloss that will make the furniture look newer for longer.



## 9. BATHROOM CABINET AND SINK

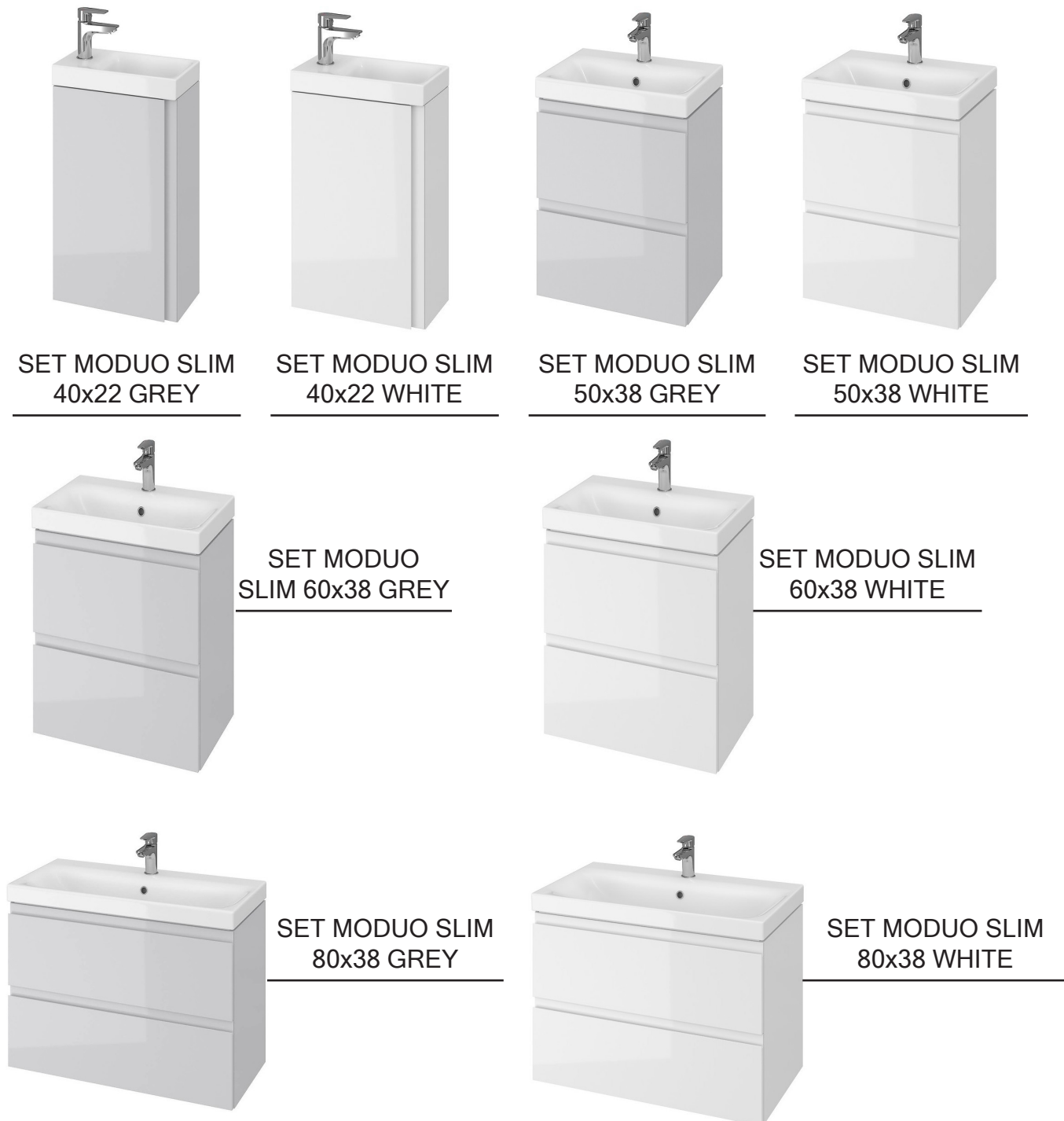

The range includes top-quality cabinets and cubicles in a variety of colours and sizes. The smart functionalities included optimise the storage space and convenience of organising your bathing utensils and beauty appliances. All bathroom furniture pieces are preserved with a quality coating system to improve the ease of cleaning. Create a beautiful and convenient bath space.

## 10. SHOWER ENCLOSURE



Sliding Door Shower enclosure  
DTr/BASIC

Square or rectangular corner shower enclosure  
KN/TX5b

STANDART SIZE 80X80, 70X90, 80X100, 70X100

## 11. TOILET



TOILET 24V/230V  
STANDARD

WALL HUNG TOILET  
UPGRADE OPTIONS

CINDERELLA STANDARD  
UPGRADE OPTIONS

CINDERELLA COMFORT  
UPGRADE OPTIONS

# 12. IKEA KITCHEN

## 12.1 KITCHEN FRONTS



VOXTORP WHITE WITH  
OUT HANDLES

003.975.00



KUNGSBACKA

203.373.41



VOXTORP GREY WITH  
OUT HANDLES

704.540.97



RINGHULT LIGHT WHITE

702.051.02



ASKERSUND JESION

203.318.72



BODARP

904.355.45

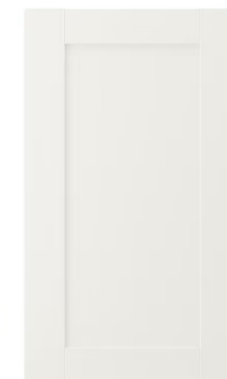

SÄVEDAL

402.930.01

With the ikea system you have endless of possibilities when designing your kitchen. Whether you have a taste for the traditional, love the minimalism in modern style or land somewhere in between, you'll surely find something that fits you.



## 12.2 WORKTOP

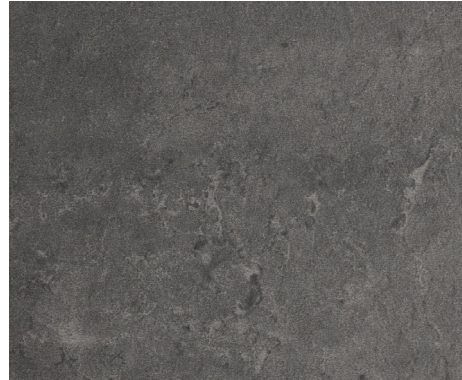

EKBÄCKEN BLACK STONE  
902.743.64

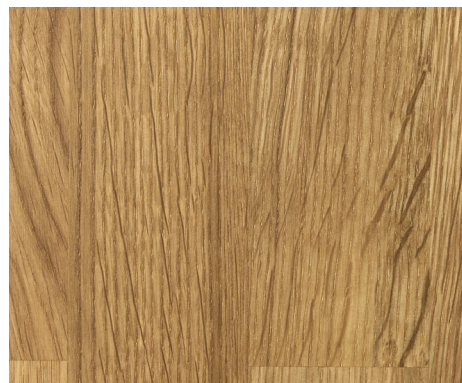

KARLBY OAK  
703.351.89



EKBÄCKEN LIGHT GREY  
503.954.43



SÄLJAN OAK  
604.391.73

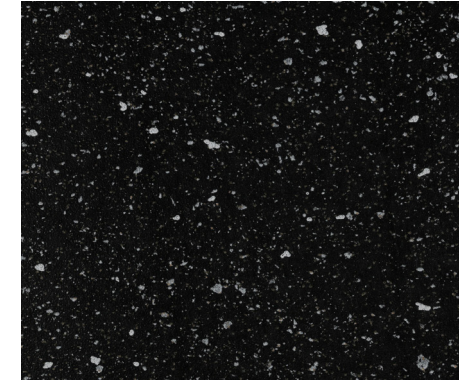

SÄLJAN BLACK MINERAL  
702.022.12

### 12.2.1 KITCHEN WALL



WHITE WALL PLATE

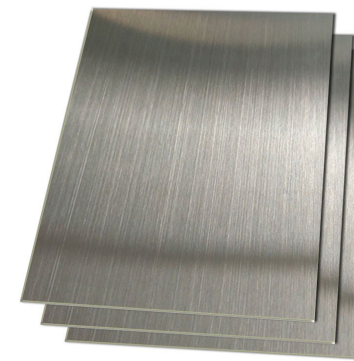

STAINLESS STEEL PLATE



SCANDINAVIAN GREY  
WALLPAPER

Our ready-made and custom-made kitchen worktops are tested against everyday kitchen challenges like liquids, oil, food and scratches – so you know they will last.



12.3 SINK



BOHOLMEN 47X30

991.575.01



FYNDIG 46X40

591.580.03



LANGUDDEN 46x46

591.573.91



CHICHI-LAVEO



ZORBA: ZQZ 2513



ZORBA: ZQZ G11A

UPGRADE OPTIONS



FYNDIG 70X50

Find sinks and taps to add the finishing touches to your kitchen here. Our kitchen sinks and taps are all as good-looking as they are functional, with plenty of different styles to match the look of your kitchen. Whichever tap you choose, you'll save water with every use, thanks to an integrated aerator that mixes in air and reduces your water and energy consumption significantly.



# 12.4 KITCHEN TAPS



ALPINE: BGA 063M



ÄLMAREN  
004.551.61

## UPGRADE OPTIONS



ASTER: BCA B730



NEMEZJA: BEN 262M



SILIA: BQS B730

12.5 HANDLES



BAGGANAES BLACK  
803.384.13



BAGGANAES SILVER  
703.384.18



BAGGANAES GOLD  
003.384.07



HACKAS  
303.424.79

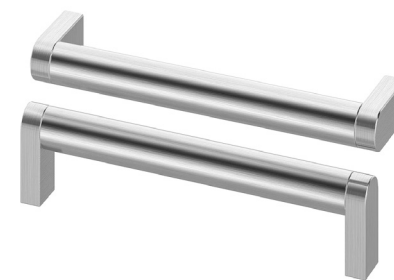

ORRNAES SILVER  
702.361.51



OSTERNAS  
403.488.95



OSTERNAS DOWN  
203.488.96

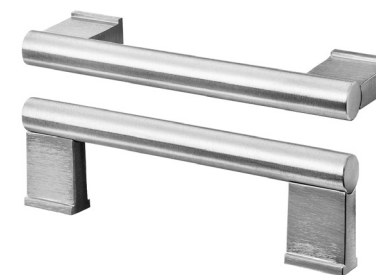

VINNAL SILVER  
201.166.98

Knobs and handles are an important finishing touch to your home. Drawer knobs make your cabinets easy to open, while door handles can really tie your room together. We've got a wide range of colours, shapes and sizes to choose from.

Most of our designs come in both a knob and handle version, too!



# 13. KITCHEN STOVE AND FRIDGE

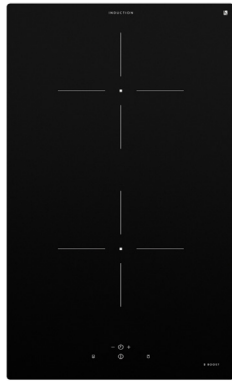

INDUCTION  
VÄLBILDAD  
204.675.92



CAN HOB, 2 BURNERS  
GAS



SMALL FRIDGE

## UPGRADE OPTIONS

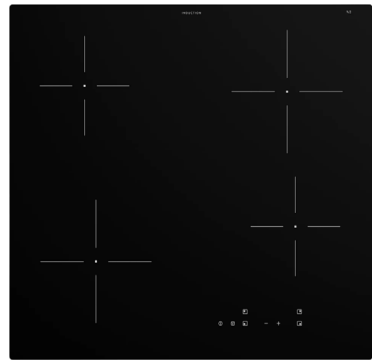

INDUCTION GRUNDAD  
404.670.82



CAN HOB, 3 BURNERS  
GAS



DYNACOOK X2  
GAS, NO FLAME



BIG FRIDGE

Gas hob, glass ceramic or energy-saving induction? How many burners would you like? Our range of hobs has something that will match your space and your style of cooking. Check out our range for a choice that will make your time in the kitchen easier and more fun, every day. Don't forget to add a kitchen extractor fan, to keep cooking fumes out of the rest of your home.

# 14. MICROWAVE AND DISHWASHER



MATTRADITION  
403.687.89



MICROWAVE WITH  
OVEN



DISHWASHER

## 15. OVEN



MATTRADITION BLACK  
804.117.24



MATTRADITION WHITE  
304.117.26



SMAKSAK BLACK  
904.117.28



SMAKSAK CHROME  
304.116.89

Our range of ovens and built-in ovens are designed to suit a variety of cooking styles by offering a wide range of functions and integrated accessories. That means, whether you're a frozen pizza lover, feeding a family, or working your way through cookbooks, you'll find an oven that's right for you. See our range of appliances.

# 16. BAR

## 16.1 BAR TABLE



## 16.2 BAR LAMP



GOLD LAMP



MARKSLÖJD LAMP



BLACK LAMP x3



WHITE LAMP x3

With the flick of a switch, you can change a room's atmosphere with a lamp or light fixture. Want a cozy, calm vibe for movie night? Some pep to start your day? Indoor lighting can set the mood, add style and of course, brighten things up.

# 17. OUTSIDE WINDOWS AND DOORS

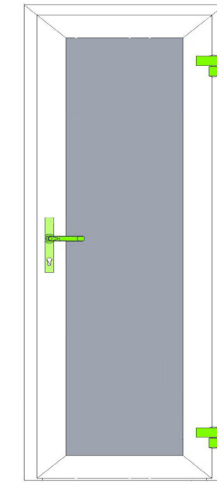

BACK DOOR

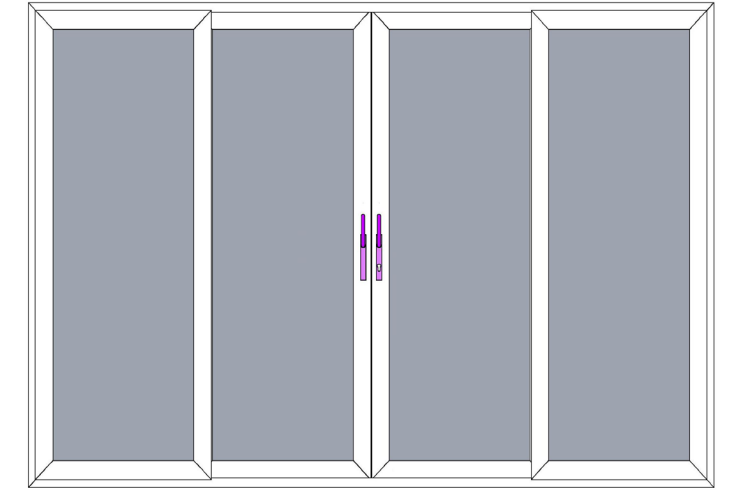

FRONT DOOR



SIDE WINDOWS

FROM APART L TO XXL  
2 GLASS FOR XS, S, M



ANTHRACITE

## OPTIONS



BLACK



WHITE



# 18. RAILINGS

## MADE OF STAINLESS STEEL

STEEL 304 or STEEL 316(non standard)

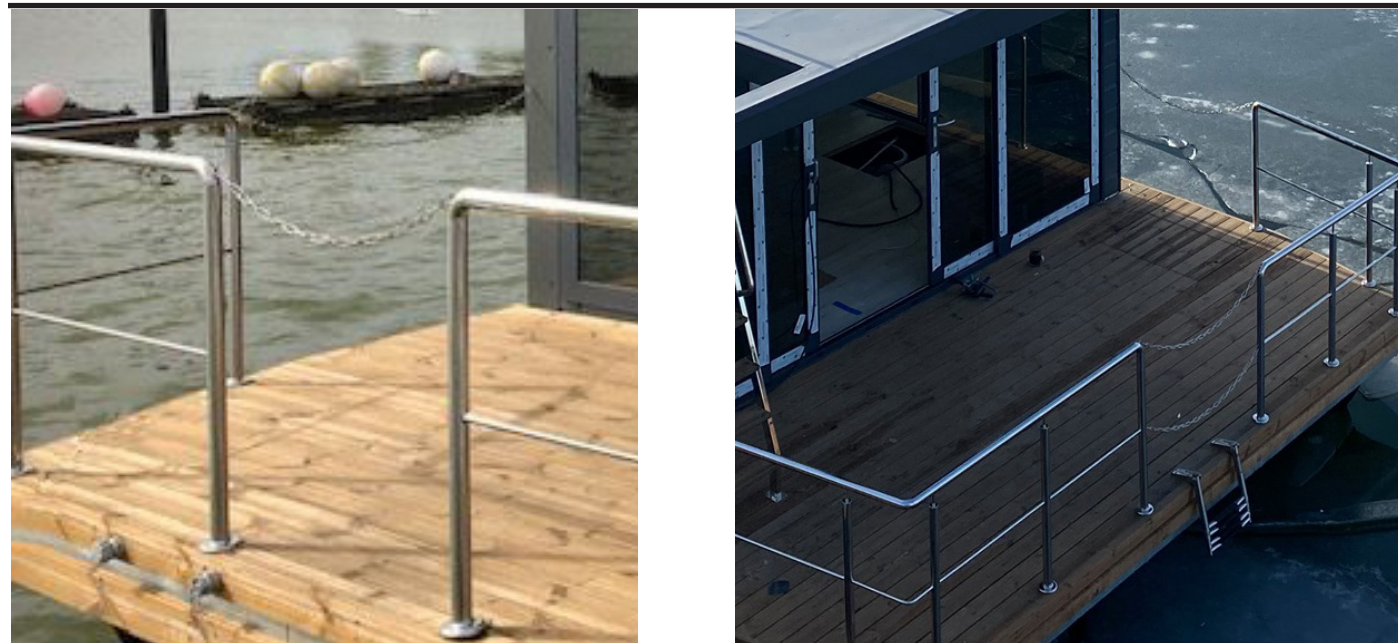

FRONT AND BACK RAILINGS

# 19. TERRACE BOARD AND CLEAT



THERMORY THERMO



CLEAT

# 20. WATER PUMPS LA MARE



WATER PUMP 230V

WATER PUMP 24V

# 21. SWITCHES, SOCKETS, SOLAR SYSTEM

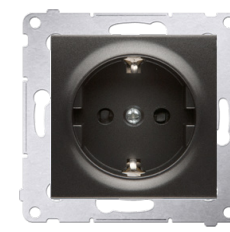

ANTHRACITE



WHITE



BACK SOCKET CONNECTION



FRONT SOCKET CONNECTION



ANTHRACITE

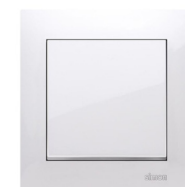

WHITE



NAVIAGATION LAMP 360



CABLE 15M

We have an excellent relationship with all of our suppliers, giving us unrivalled access to the products you need, including a large range of distribution, automation, control and switchgear products.





INVERTER 2.4 KW / 5 KW



SOLAR PANEL 310W



VETUS 220AH



VICTRON ENERGY 220 AH



WIFI CONTROL

WHITE REGULAR RADIATOR

RADIATOR 30/50

40/60/80/100/120

OPTIONS

## 22. HEATING AND BOILER

### 22.1 HEATING FURNACE



GAS HEATER - TERMET ECOLINE SLIM



AIR CONDITIONER



UNDERFLOOR HEATING OPTION - HEATING MAT



HYBRID 550W IVORY

### 22.2 BOILERS



WATER HEATER, ARISTON 50L BOILER



WATER HEATER, ARISTON 50L BOILER, WI-FI (OPTIONS)



## 23. DECORATIVE RADIATOR



ANTHRACITE



BLACK

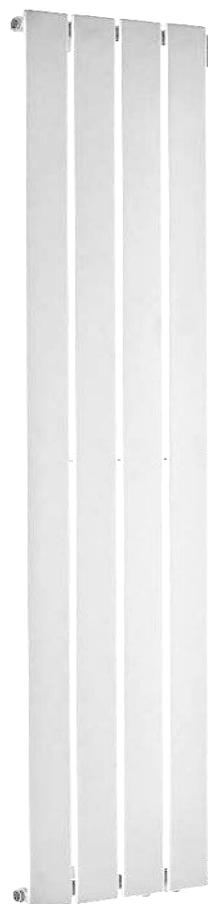

WHITE

## 24. BATHROOM LADDER HEATER



ELECTRIC

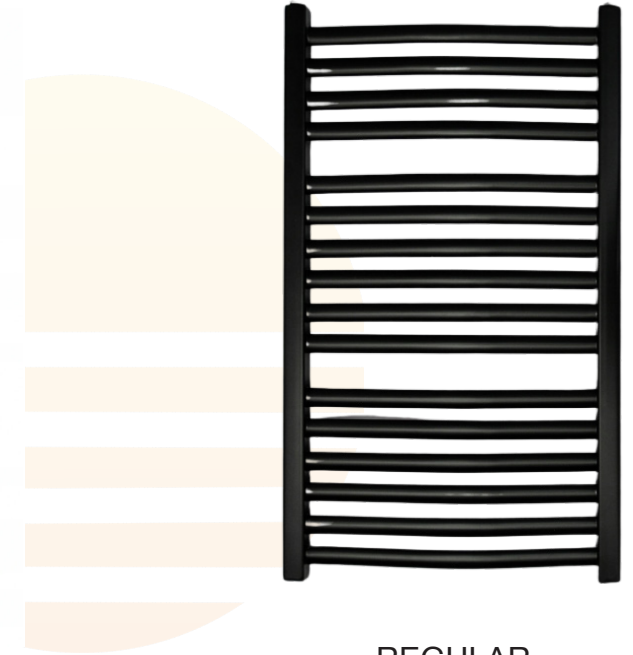

REGULAR

WIDTH 30 OR 50 CM

We want our houseboats to be comfortable, for some people that means control over the settings and temperature, for others uncompromising energy efficiency is most important, and many are looking for quiet performance at a price you can afford. Our goal is to give you that ideal indoor comfort, no matter where you live or what the weather.

## 25. GAS BOX AND GAS SWITCH



GAS SWITCH



GAS BOX





IS THE LEADING BOATBUILDER IN EUROPE

# ADDITIONAL EQUIPMENTS



# 26. FLOATING PACKAGE

## 26.1 NAVIGATION LIGHT AND ROPES



360 AND SIDE LIGHTS



360 AND BSH LIGHTS



ROPES

## 26.2 SONARS



SONAR ELEMENT 7, GPS, HV-100



SONAR I40 DEPTH

# 26.3 ENGINES



YAMAHA 9.9 HP



HONDA 20 HP



MERCURY 15 HP



YAMAHA 25 HP



E-TECH



TRUSTER



FUEL SEPARATOR



FUEL TANK 100 OR 70 L.

Marine engines: a key technology in continuous innovation  
 Since the first steamship was invented, sea engines provide motion, reliability and safety to both people and goods. It is an extremely important technological system for the boating world, which over the years has been working to significantly extend the quality of its equipment, in terms of performance and life span.



## 26.4 STEERING CONSOLE AND WHEEL



BLACK



WHITE

### STEERING CONSOLE EXAMPLE



CHOICE WHITE/GRAY



CONSOLE COVER

Steering console for houseboats with a lot of adjustment features. The easy use of the steering console adds to boating pleasure.

## 26.5 ANCHOR, BEAMS AND FLOATS

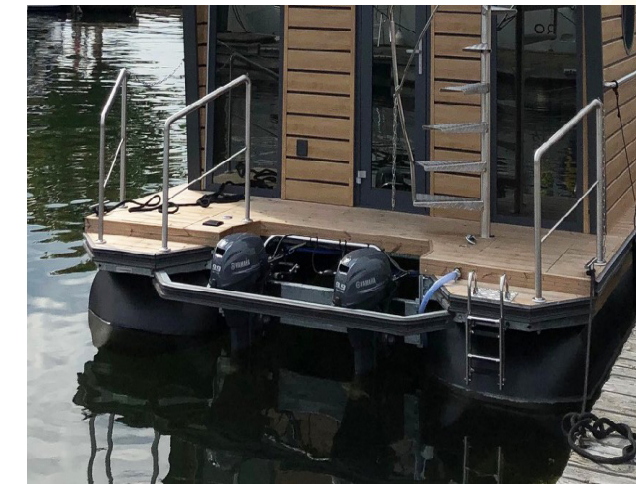

EXTRA FRAME AROUND ENGINE



ENGINE CONSTRUCTION WITH OPEN TERRACE

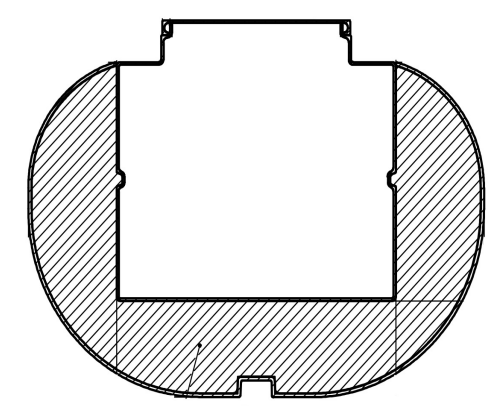

BOX IN FLOAT 470L



TRIMARAN



ANCHOR AND CHAIN



ELECTRIC



MANUAL



# 27. MODIFIED WINDOWS AND DOORS

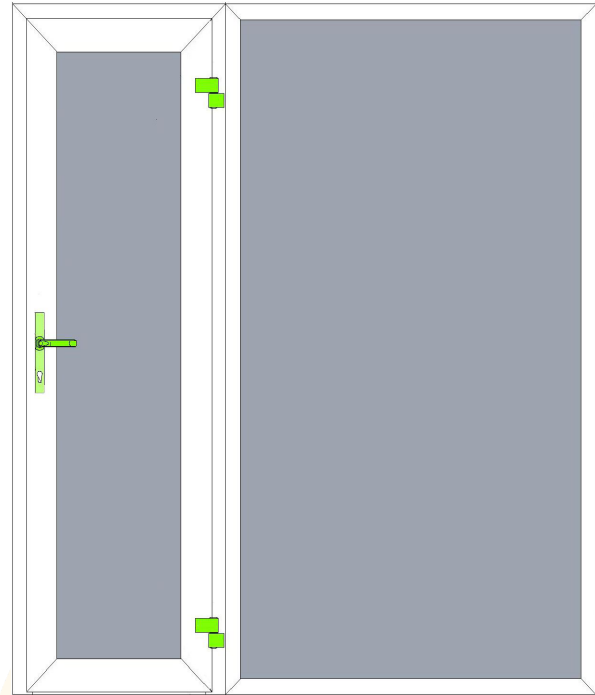

BACK DOOR

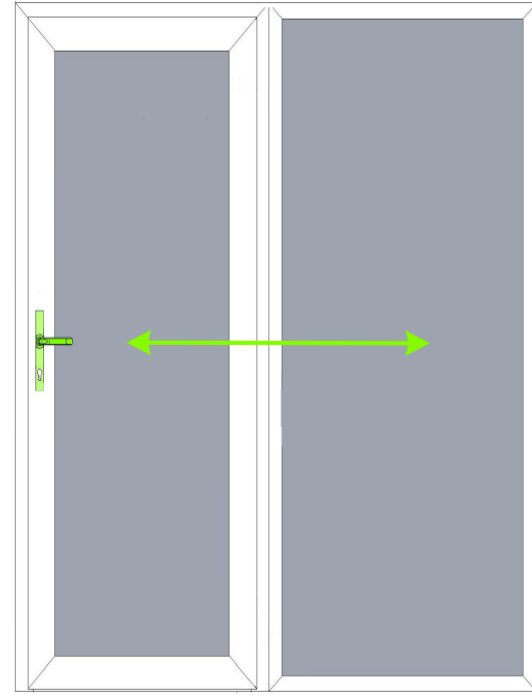

BACK SLIDE DOOR

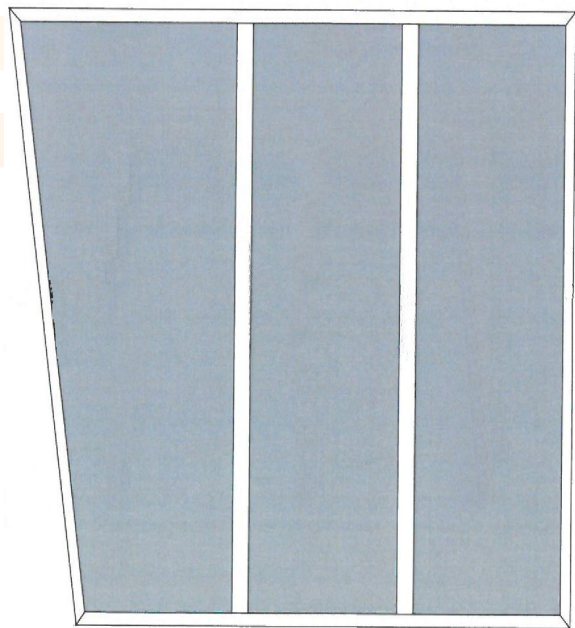

SIDE WINDOWS

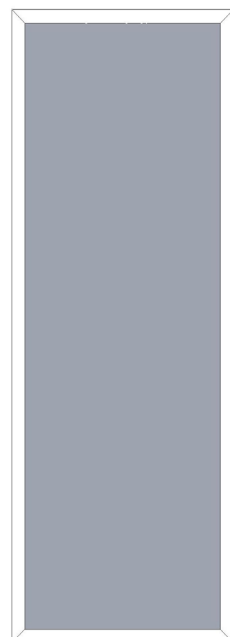

SINGLE SIDE WINDOW

We offers vast range of windows & doors designs for the houseboats that are sure to add grace to your space. We have an exotic range of high-quality aluminium home windows & doors that have been designed to enhance the aesthetics and to protect your home from the chaos of the world outside.

# 28. STAIRCASE

## 28.1 SPIRAL



S1

FROM APART L TO XXL

## 28.3 LADDER



S3

FOR APART XS, S, M

## 28.2 STRAIGHT



S2

FROM APART L TO XXL

## 28.4 FRONT STRAIGHT



S4

FROM APART L TO XXL



# 29. SIDE RAILINGS AND FLEXI TEAK



SIDE RAILINGS



FLEXI TEAK

# 30. WATER-WASTE SYSTEMS



24V FAECES PUMP



WASTE PUMP CONNECTION



CLEAN WATER FROM TANK



CLEANING WATER SYSTEM FROM SALT WATER



LAMARE SEWAGE TREATMENT PLANT

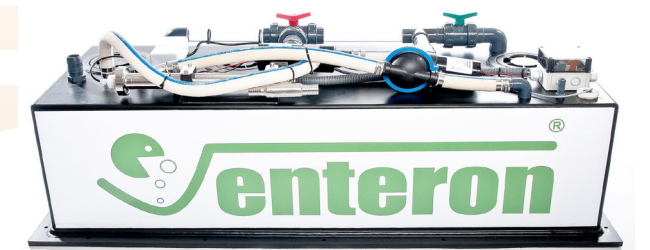

ETHERON 50 SEWAGE TREATMENT PLANT



# 31. BEDROOM

## 31.1 WARDROBE AND BED



PAX 50cm/60cm/37cm X 201cm



BED 130/140cm X 200cm or 160cm X 200cm

Bedroom furniture sets give you a shortcut to a complete, coordinated bedroom. They have all the essentials – a bed, a handy bedside table and storage for what you wear.

# 32. TV, RADIO AND SOCKET



RADIO PIONEER



RADIO TONSIL



SPEAKERS



RADIO FUSION



CAMERA



ANTENA GLOMEX



TV's 24" 32" 40"



TV-RADIO SOCKET



BEDLAMP



PRIORITY RELAY



CONNECTION 380V SOCKET AND CABLE PLUG



# 33. SAUNA AND GRADUATION TOWER



HOME GRADUATION TOWER

ELECTRIC SAUNA FOR 2 PERSON

Order the perfect wellness and relaxation space. We have everything you need to create your own DIY sauna. All of this adds up to endless combinations to make sure that your sauna is uniquely designed for you.

# 34. CURTAINS



GREY



GRAY BLACKOUT

# 35. BLINDS



BASEL PERLA 1256  
cm 221 | cm 230 | A 6% | T 29% | R 65%



CRUSH PEARL CP7004  
cm 225 | cm 307 | A 19% | T 21% | R 60%

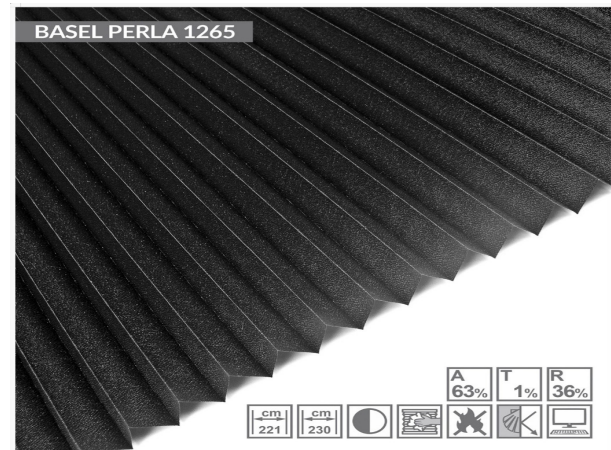

BASEL PERLA 1265  
cm 221 | cm 230 | A 63% | T 1% | R 36%



C-SERIE C1300  
cm 200 | cm 240 | A 68% | T 6% | R 26%



CALIFORNIA 3  
cm 230 | A 86% | T 3% | R 11%



C-SERIE C1320  
cm 200 | cm 240 | A 86% | T 3% | R 11%



CRUSH PEARL CP10449  
cm 225 | cm 307 | A 1% | T 30% | R 69%



PALADO 20226  
cm 230 | cm 307 | A 73% | T 3% | R 24%



# 36. MODERN

## 36.1 EXTERNAL COLORS



ANTHRACITE
BLACK
BROWN
WHITE



ANTHRACITE
BLACK
GREY
WHITE

## 36.2 KITCHEN, BATHROOM TAPS AND SHOWERS



LUGANO SLIM BLACK



REA BLACK

### BLACK SET



SHOWER ENCLOSURE BLACK



SHOWER BLACK



LUGANO SLIM GOLD



REA GOLD

### GOLD SET



SHOWER ENCLOSURE GOLD



SHOWER GOLD



### 36.3 BATHROOM CABINETS



BLACK CABINET

### 36.4 FABRIC WALLS



LIVING ROOM WALL v1



SLEEPING ROOM v1



LIVING ROOM WALL v2



SLEEPING ROOM v2

### 36.5 KITCHEN LAYOUT



STANDARD LAYOUT



# 37. LAYOUTS

## APART XS

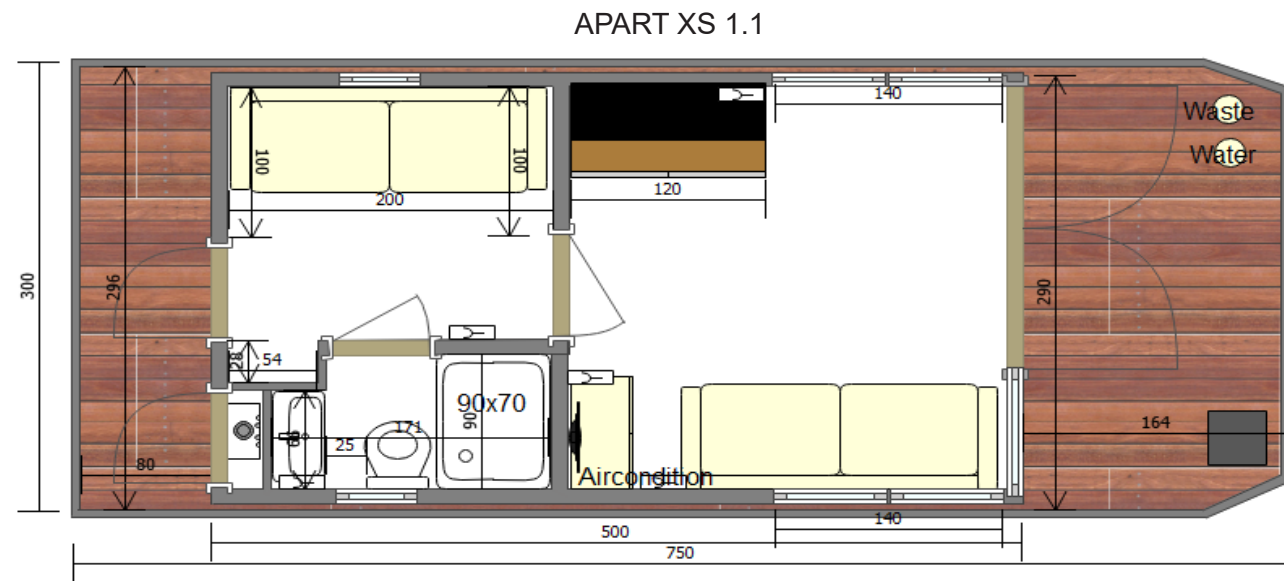

## APART S

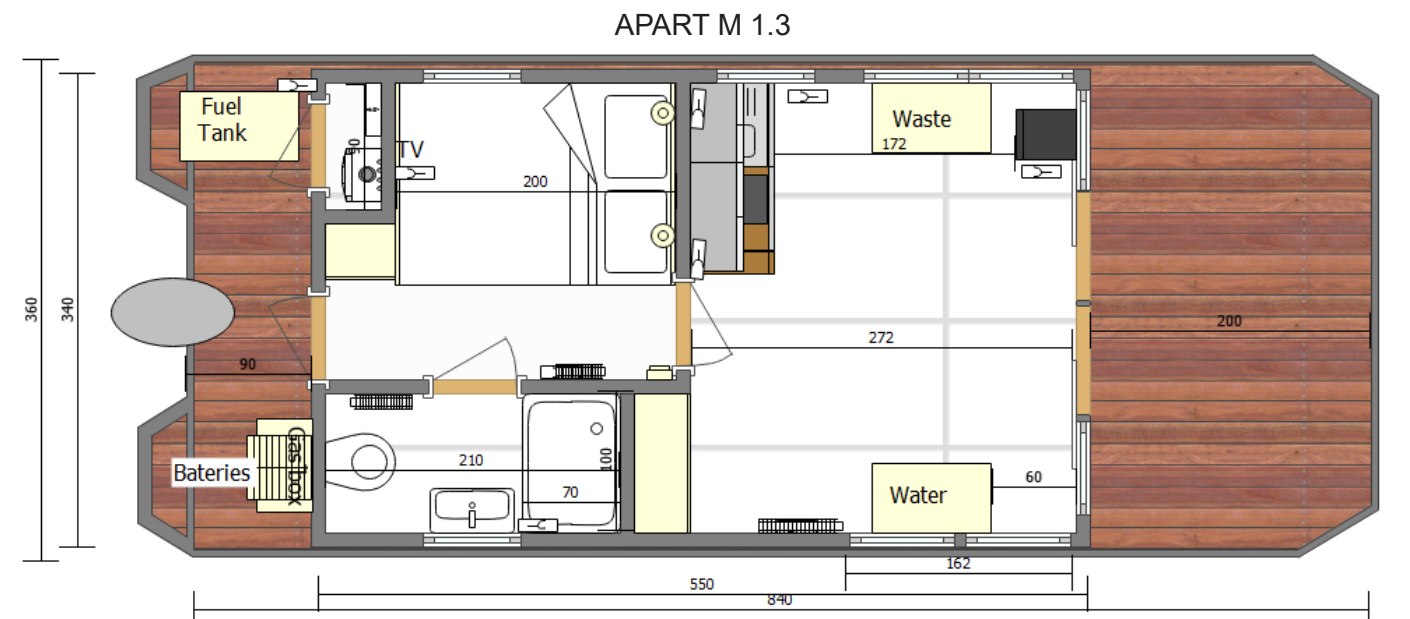
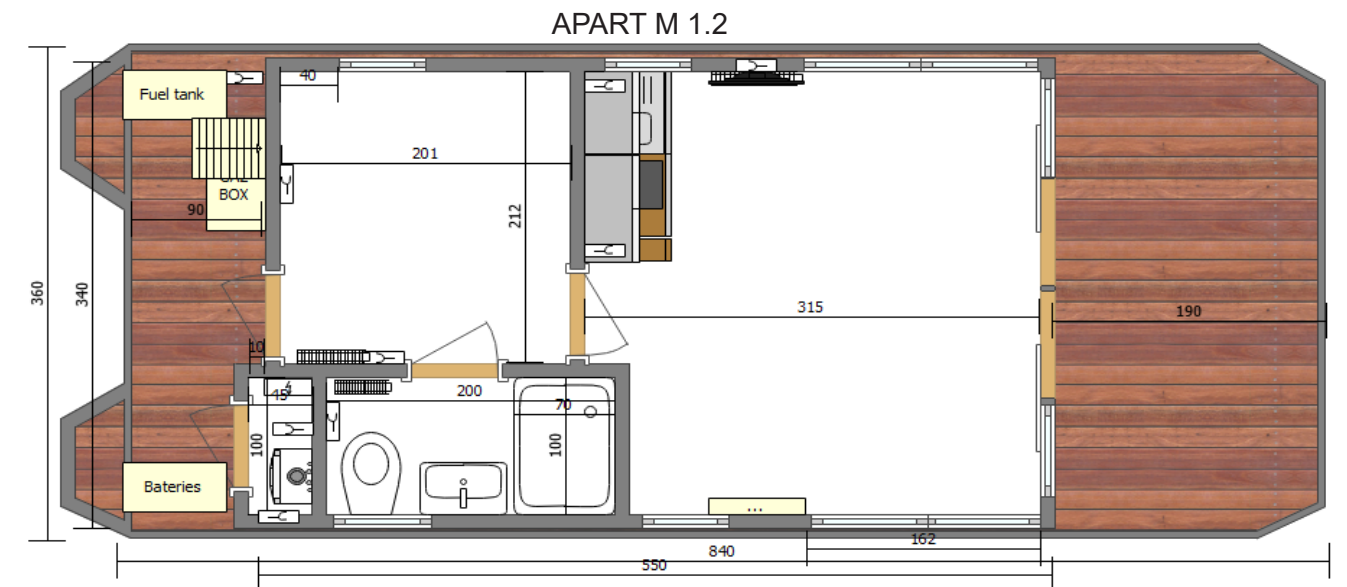
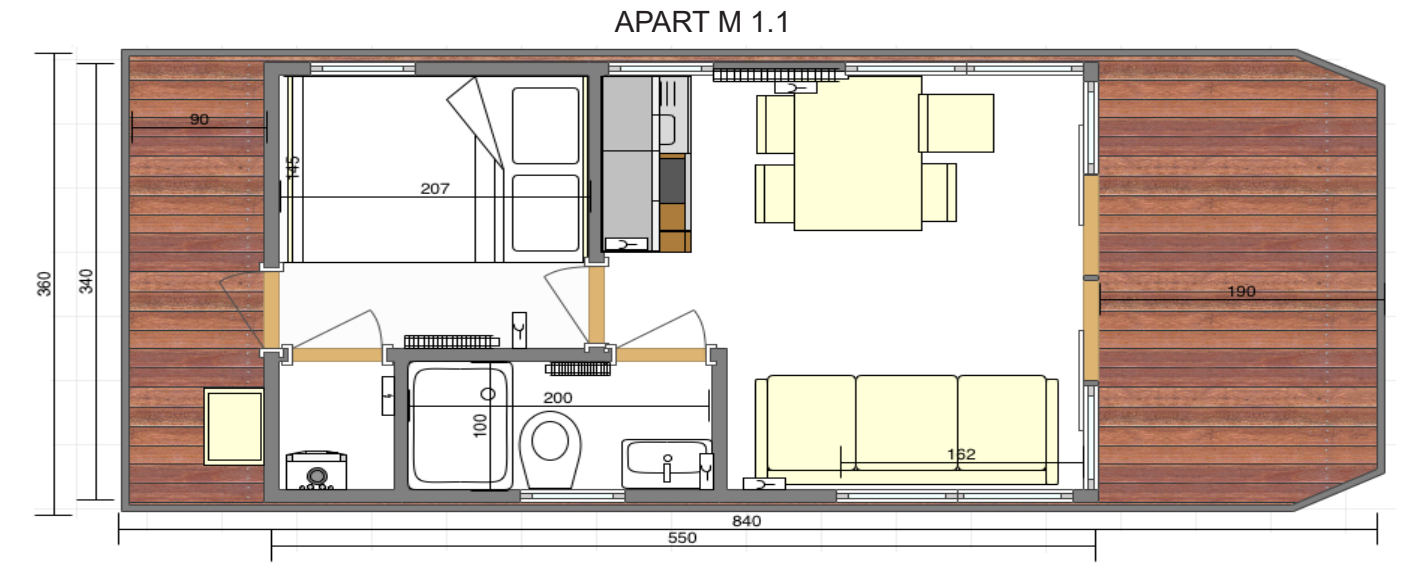
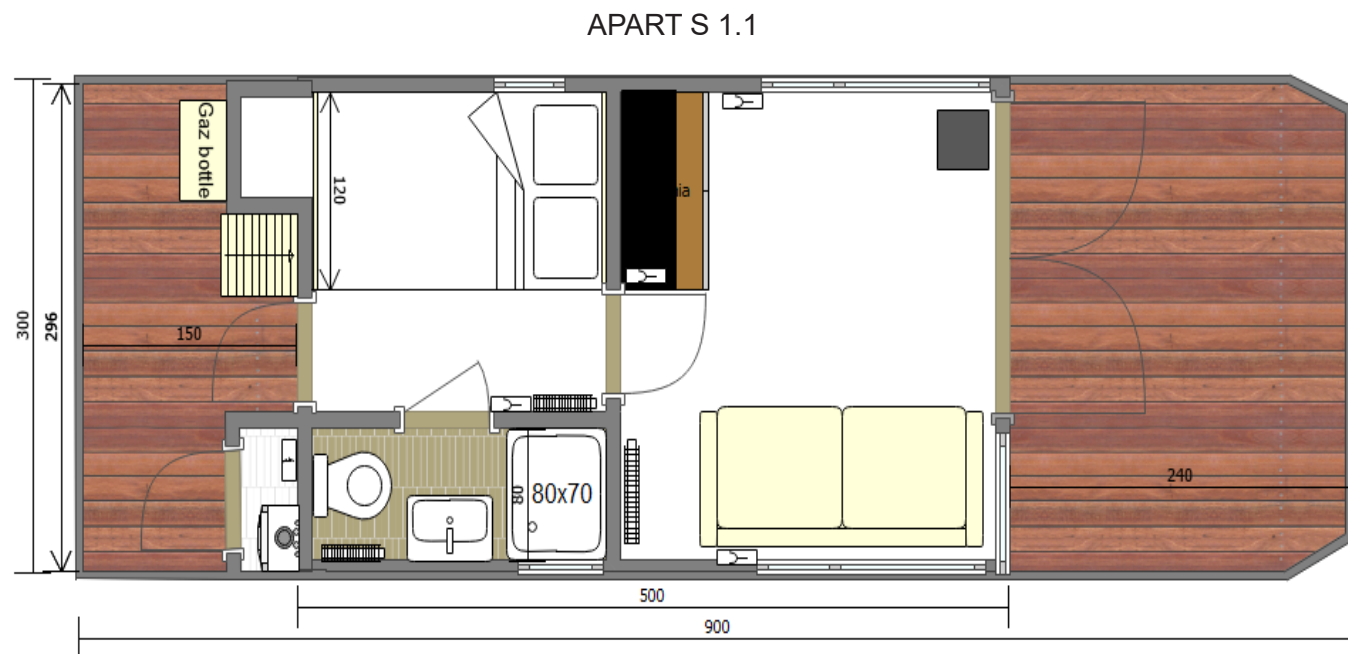

APART L

APART L 1.1

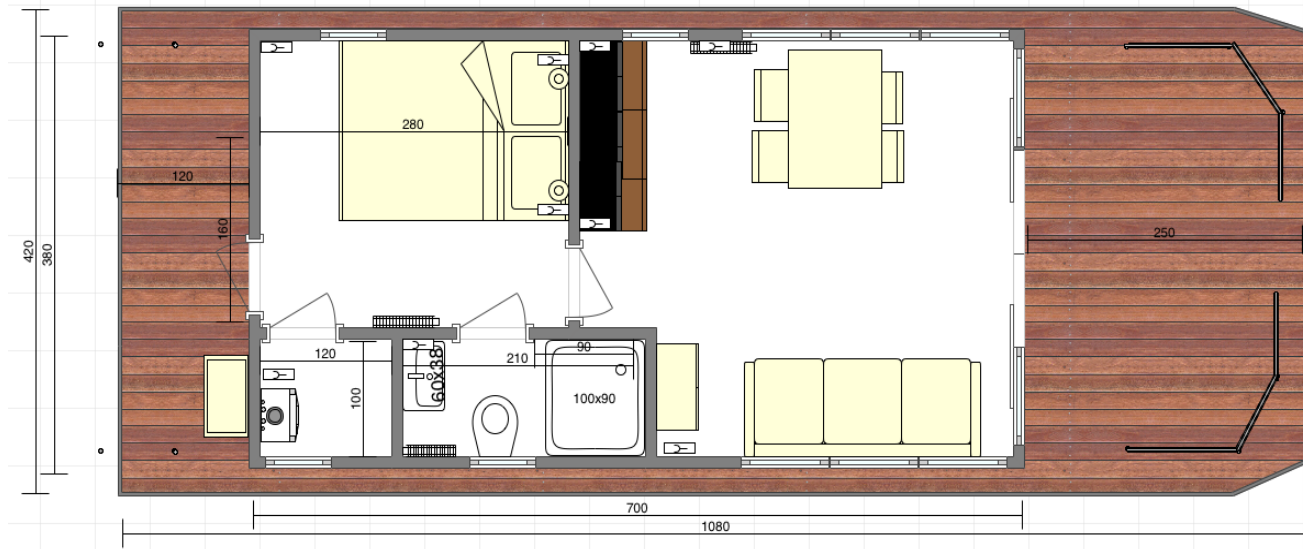

APART L 1.2

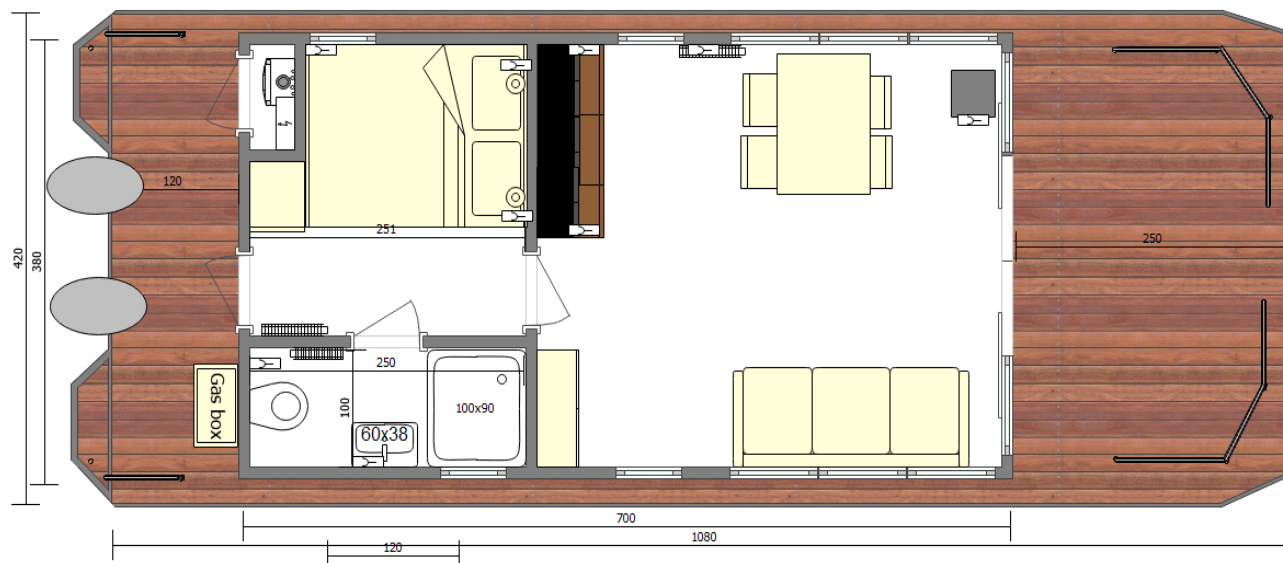

APART L 2.1

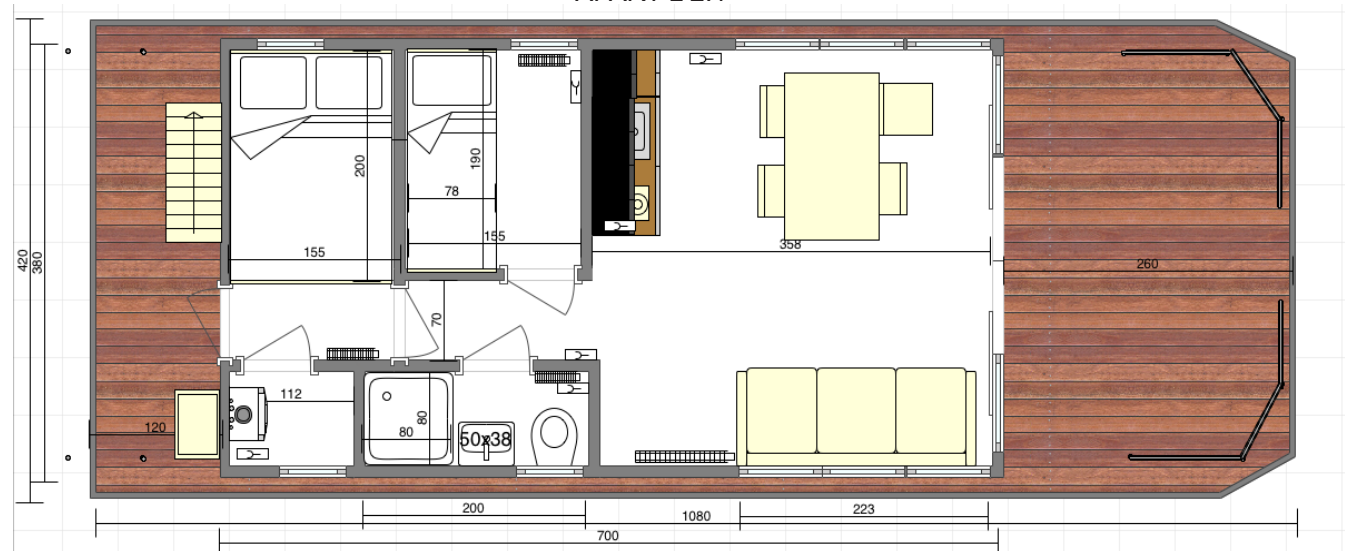

APART L LONG

APART L LONG 2.2

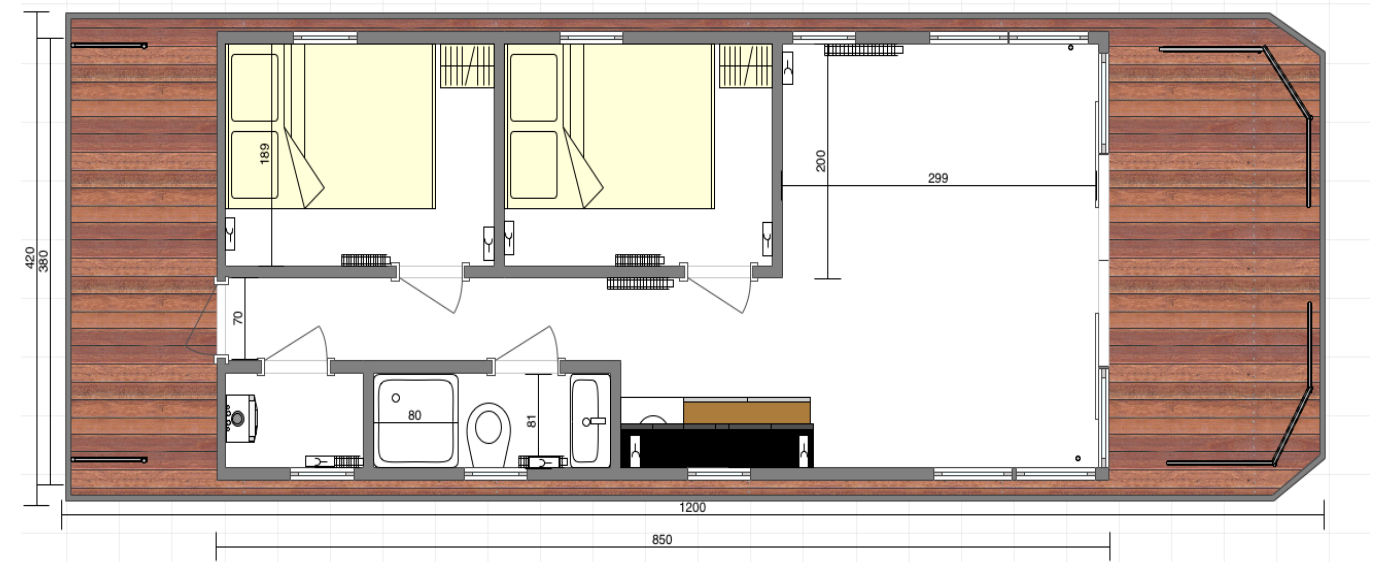

APART L LONG 2.4

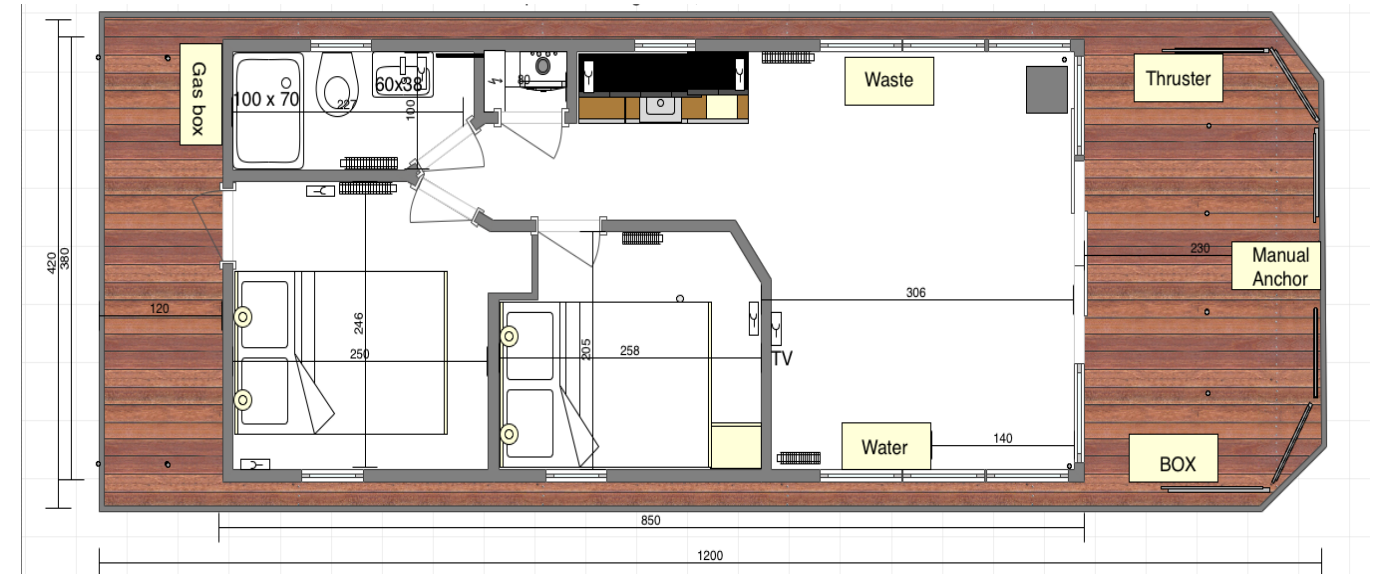

APART L LONG 2.2.1

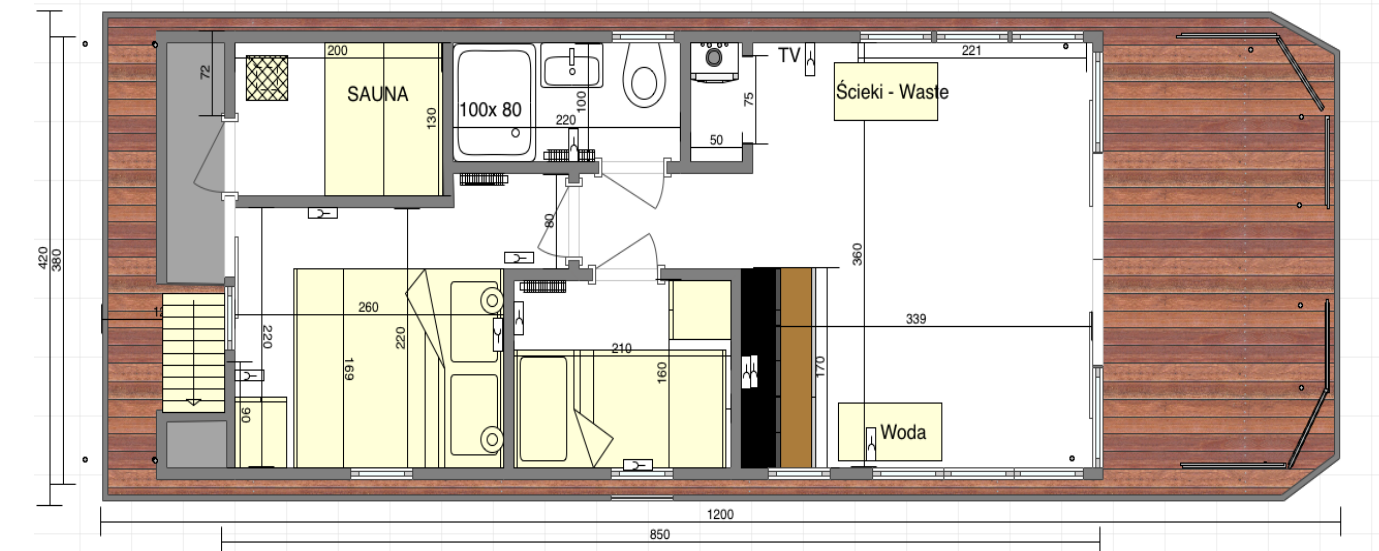



APART L LONG 2.7

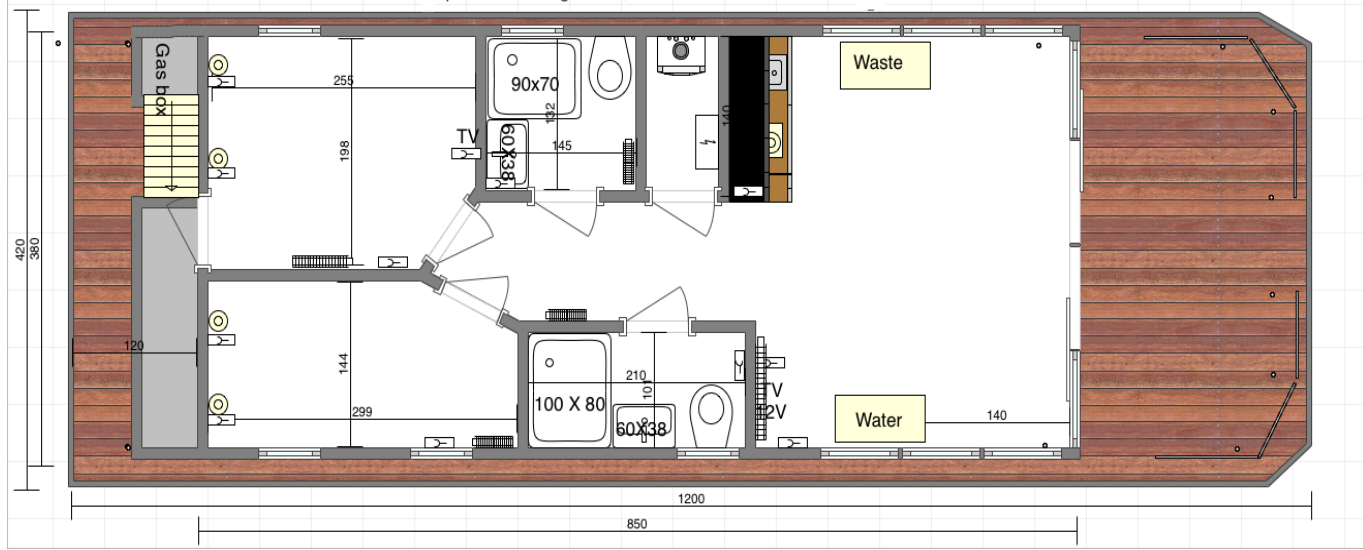

APART L LONG 2.8

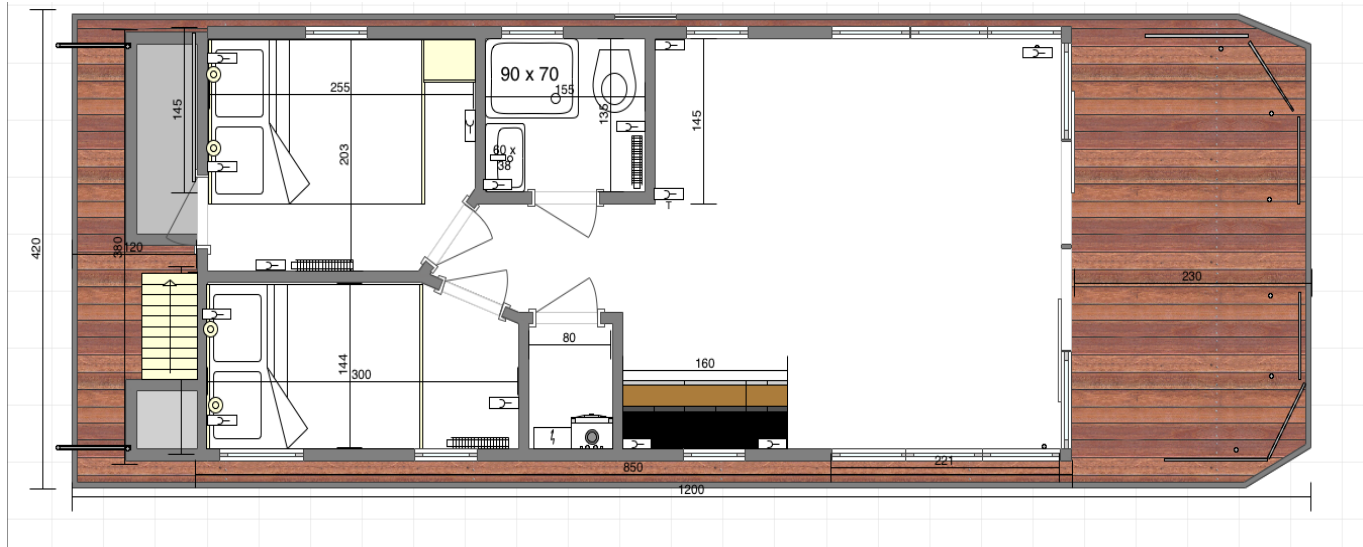

APART XL

APART XL 2.1

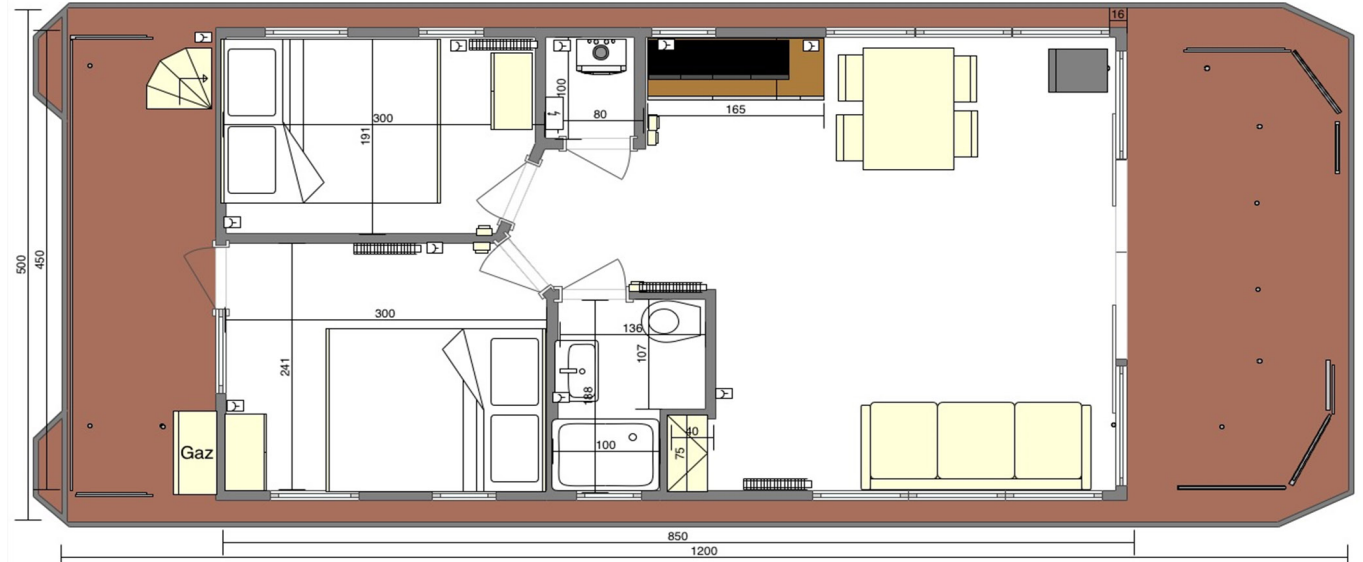

APART XL 2.2

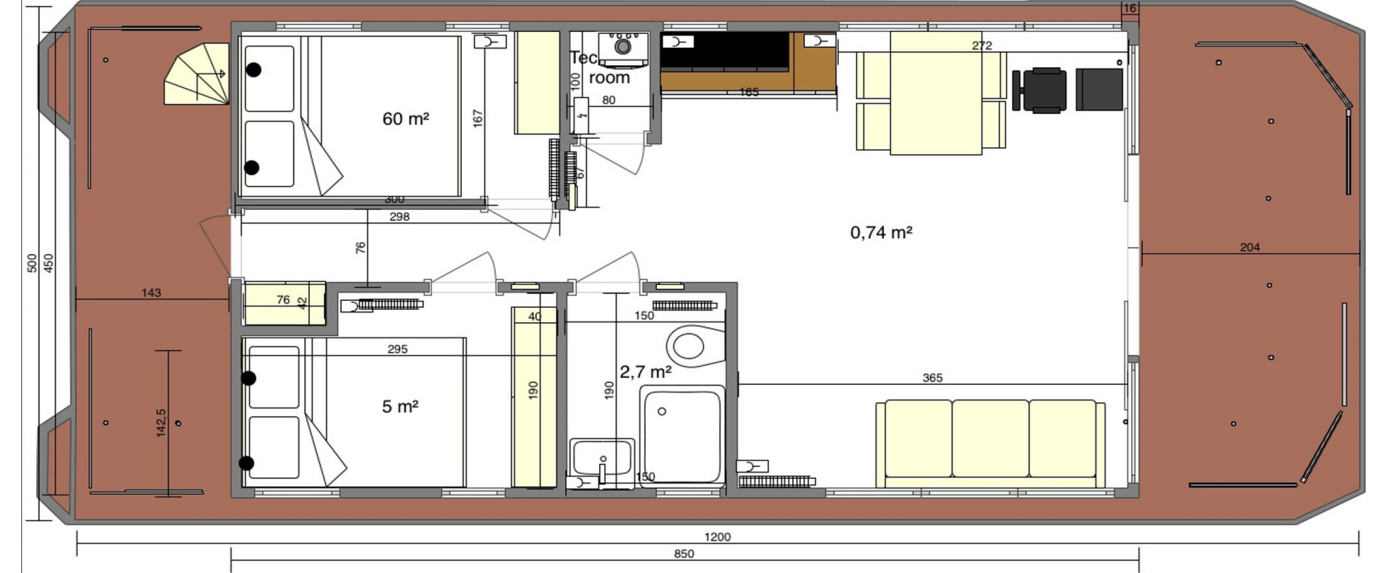

APART EL

APART EL 2.1

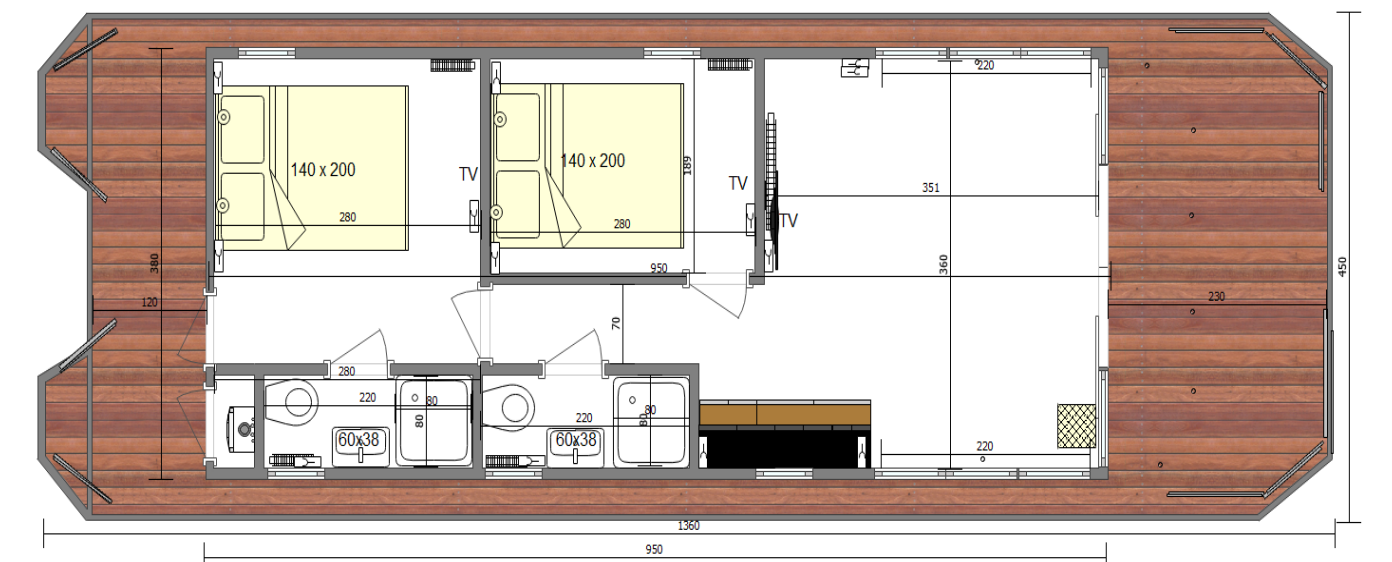

APART EL 2.2

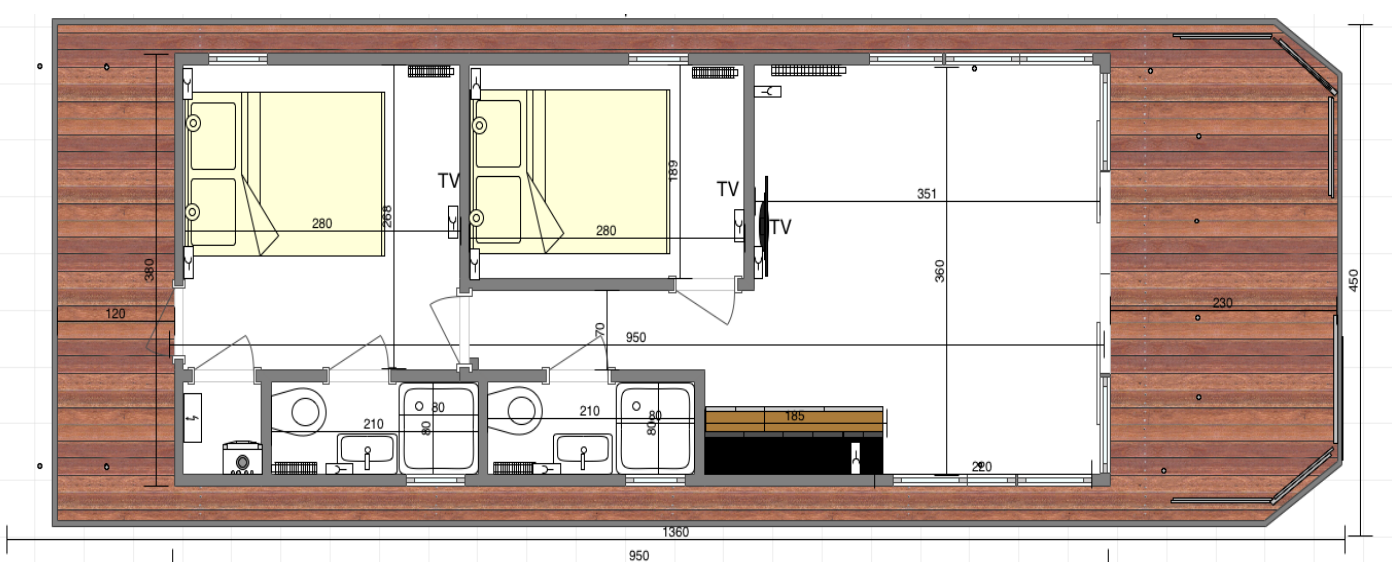



APART XXL 3.2

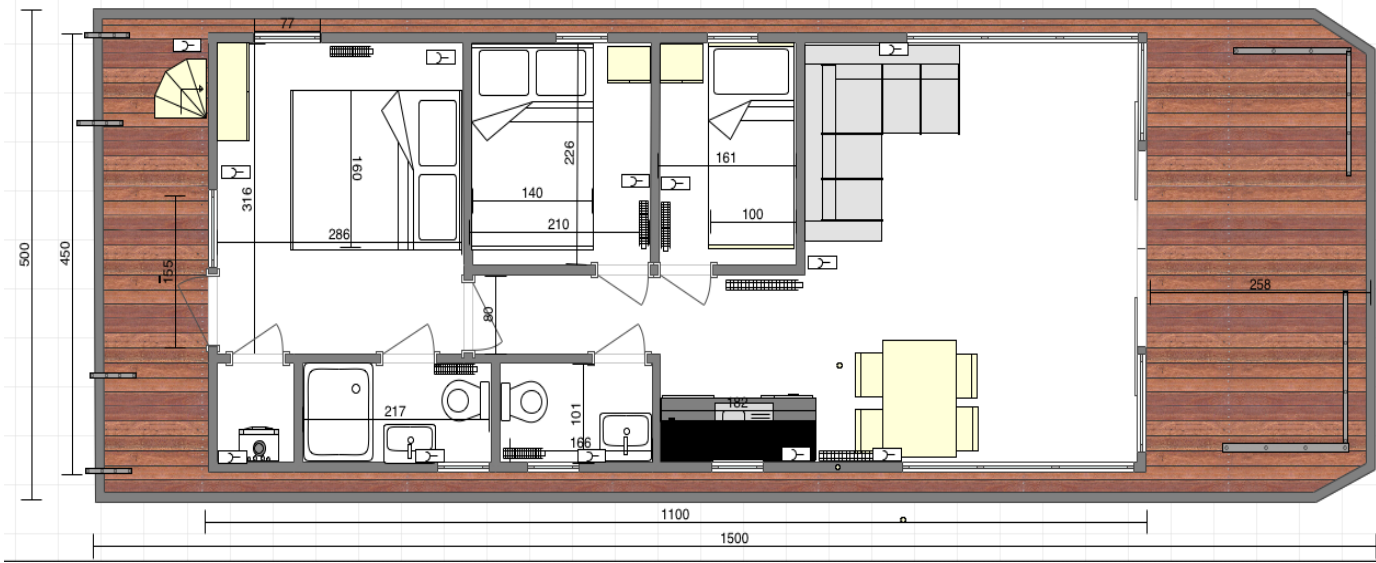

APART XXL 2.2

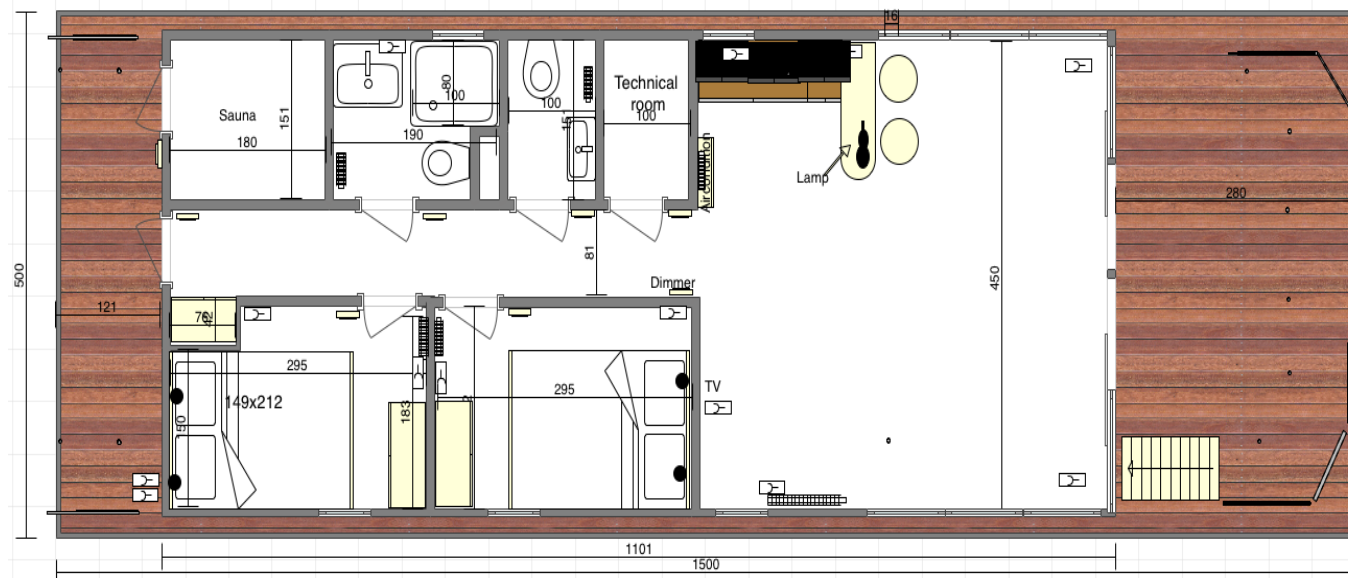

APART XXL 2.3

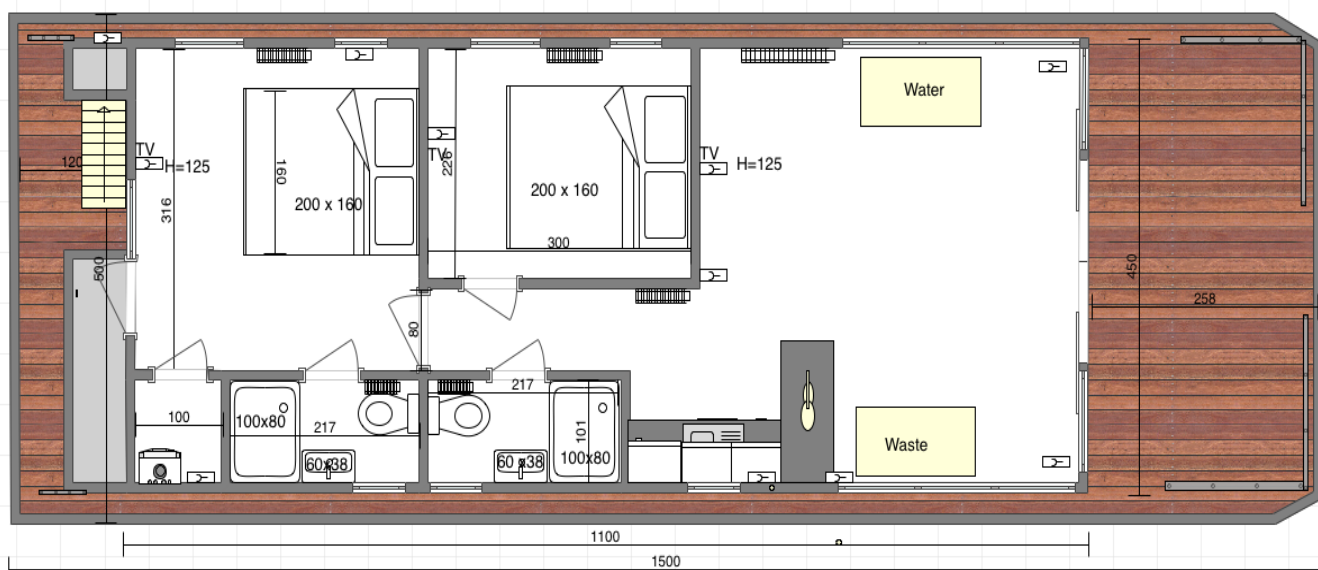

MODERN 2.1

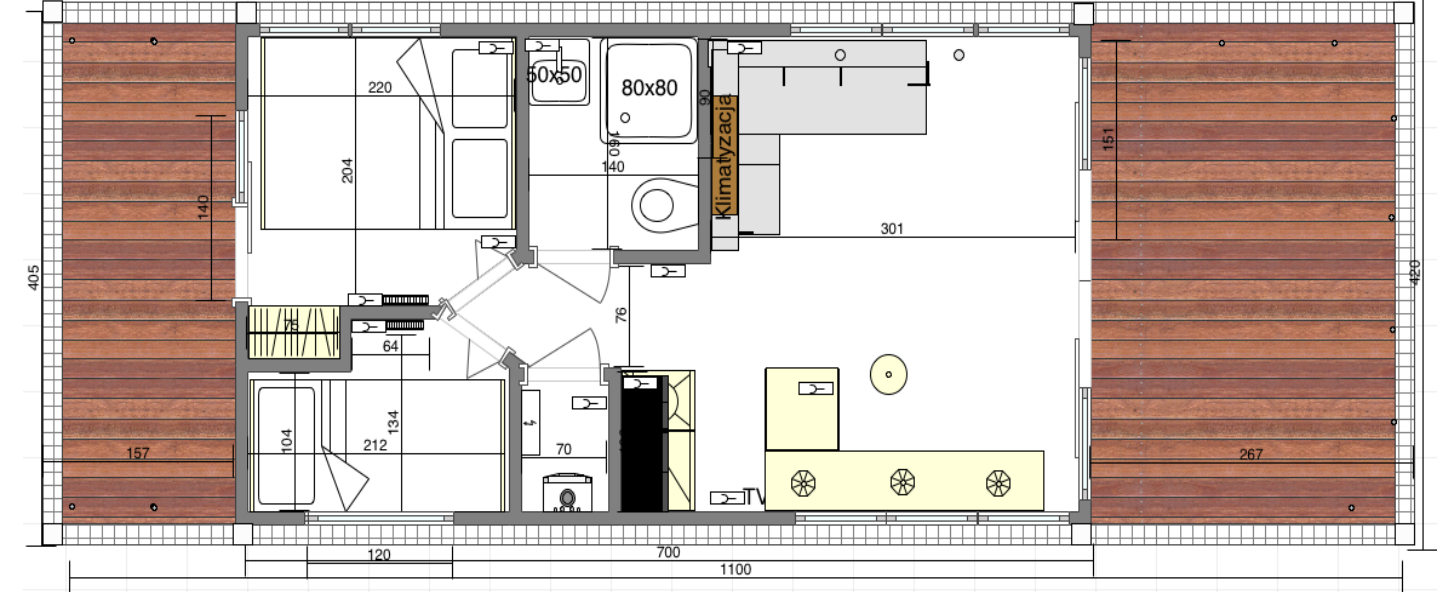

MODERN 2.2

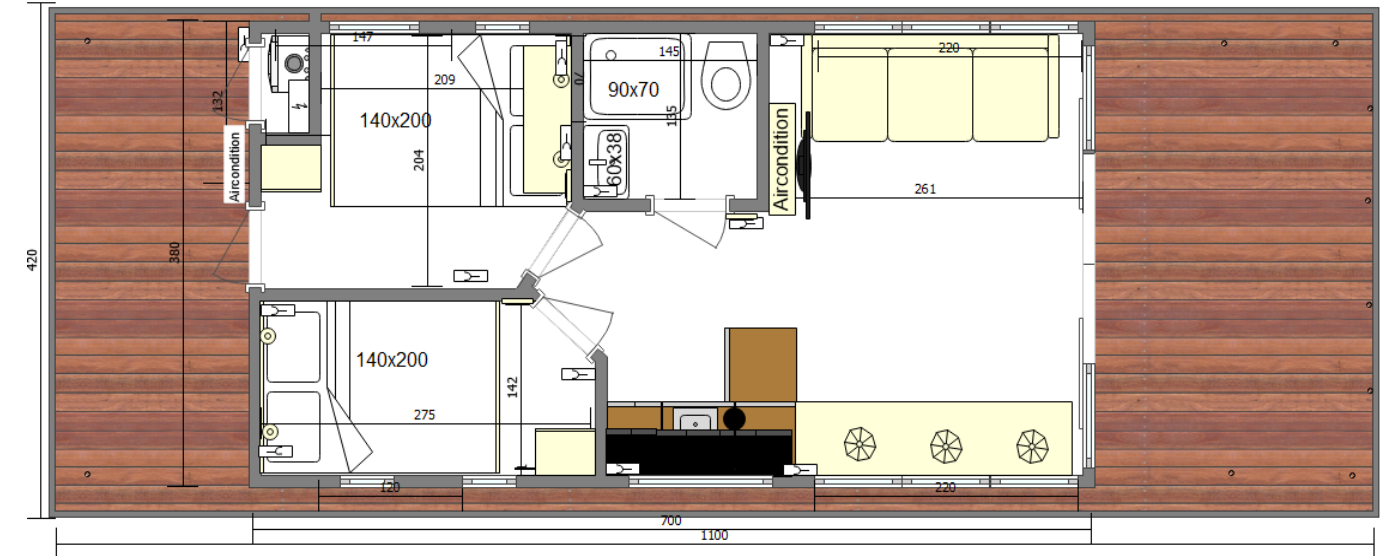



LaMare Sp. z o.o  
Bydgoszcz, Poland  
Portowa 10 str.  
85-757

LA  MARE

